







# 300 S

# 3,0 t

CE



-  Sollevatore a due colonne senza base
-  Two post lift without baseframe
-  Zweisäulenhebebühne ohne Grundrahmen
-  Elévateur a deux colonnes sans base
-  Elevador a dos columnas sin base



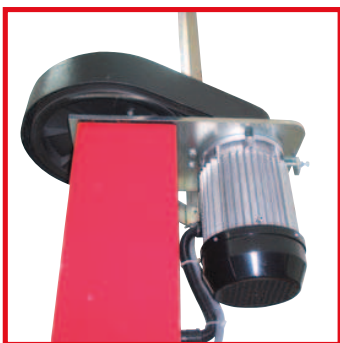

Motore speciale ad alto rendimento per garantire potenza e durata nel tempo, dotato di sonda termica di protezione

**Specially manufactured motor fitted with overheating & overload protection switch**

Spezieller Hochleistungsmotor mit Thermoschutz liefert üppig bemessene Antriebsleistung und gewährleistet lange Lebensdauer

Moteur spécial à haute performance pour garantir puissance et durée dans le temps, équipé de sonde thermique de protection

Motor especial de alto rendimiento para garantizar potencia y duración en el tiempo, suministrado con termico de protección

Vite rullata in acciaio ad alta resistenza per garantire la massima durata nel tempo.

**Steel high resistance rolled screw to provide long life**

Kaltgewaltze Spindel aus gehärtetem Stahl für eine lange Lebensdauer.

Vis en acier, roulée, à haute résistance, pour garantir la durée dans le temps

Husillo de acero de alta resistencia, rosca fabricada en frío con rodillos para garantizar la máxima duración en el tiempo



Chiocciola portante in Nylatron GSM ad elevata resistenza all'usura a garanzia di sicurezza totale

**Nylatron GSM main nut with high resistance to wear for greater safety**

Verschleissfeste Tragmutter aus Nylatron GSM gewährleistet totale Sicherheit

Ecrou porteur en Nylatron GSM à haute résistance à l'usure pour garantir une sécurité totale

Tuerca principal en Nylatron GSM de alta resistencia al desgaste para garantizar la seguridad total

 Sollevatore con sincronizzazione elettronica senza base, permette la massima comodità di movimento nella zona di lavoro. Possibilità di installazione dei cavi di collegamento al soffitto o incassati nel pavimento • La sincronizzazione elettronica fra i carrelli mantiene il dislivello entro un massimo di 24 mm • Due motori speciali ad alto rendimento per garantire potenza e durata nel tempo, dotati di sonda termica di protezione • Comandi in bassa tensione • Bracci corti e bracci lunghi a tre stadi per il sollevamento asimmetrico di furgoni e fuoristrada • Bracci super-ribassati, con profilo parallelo al pavimento • Tamponi con altezza minima di soli 95 mm • Lubrificazione permanente e automatica della vite • Funzionamento: elettromeccanico

 Lift with electronic synchronisation without baseframe for easy movement in the working area. The connecting cables can be fixed to the ceiling or recessed into the floor • Electronic synchronisation between carriages to keep the height difference within max 24 mm • Two specially manufactured high performing motors to provide long life; fitted with protecting thermic sensor • Low voltage controls • Short and long three-stage arms for the asymmetric lifting of vans and 4-wheel drive vehicles • Super lowered arms parallel to the floor • Pads min. height 95 mm. only • Permanent and automatic screw lubrication • Operation: electro-mechanical

 Hebebühne mit elektronischer Gleichlaufsteuerung ohne Grundrahmen für die einfachste Bedienung in der Arbeitszone. Die Verbindungskabel können sowohl über die Decke oder im Boden verlegt werden • Die elektronische Gleichlaufsteuerung regelt den Gleichlauf der Hubschlitten und beschränkt den Ungleichlauf auf max. 24 mm • Zwei spezielle Hochleistungsmotoren mit Thermoschutz liefern üppig bemessene Antriebsleistung und gewährleisten lange Lebensdauer • Bedienelemente liegen alle an Niederspannung (24 volt) • Dreifach teleskopische lange und kurze Arme, um die problemlose asymmetrische Aufnahme von Lieferwagen und 'Off-Road'-Fahrzeugen zu gewährleisten • Sehr niedrige Arme • Aufnahmen mit einer Mindest-Unterschwenkhöhe von 95mm • Automatische Dauerschmierung der Spindel • Funktionsweise: elektromechanisch

 Elévateur avec synchronisation électronique sans base, facilitant le mouvement dans la zone de travail. Installation des câbles de connexion au plafond ou encastrés au sol • La synchronisation électronique entre les chariots limite la dénivellation à un écart max de 24 mm • Deux moteurs spéciaux à haute performance garantissent puissance et durée dans le temps; équipés de sonde thermique de protection • Commandes à bas voltage • Bras courts et bras longs en trois parties pour le levage asymétrique de fourgons et tout-terrains • Bras super-baissés avec profil parallèle au sol • Tampons de hauteur min. de 95 mm seulement • Lubrification permanente et automatique de la vis • Fonctionnement: électro-mécanique

 Elevador con sincronización electrónica sin base: permite un fácil acceso al área de trabajo. Posibilidad de instalación de los cables en el techo o empotrados en el suelo • La sincronización electrónica entre los carritos permite mantener un plazo máximo de desnivelación de 24 mm • Dos motores distintos y de alta eficiencia para asegurar potencia y duración en el tiempo, ambos con sonda térmica de seguridad • Controles a bajo voltaje • Brazos cortos y largos a tres etapas para levantamiento asimétrico de furgonetas y vehículos de todoterrenos • Brazos extra rebajados con perfil paralelo al suelo • Tampones con altura máxima de sólo 95mm • Lubricación permanente y automática del tornillo • Funcionamiento: electro-mecánico



# 300 S

# 3,0 t



Arresto bracci a inserimento automatico e sgancio automatico a terra

**Automatic locking & unlocking of arms during on floor**

Schwenkarmarretierung rastet automatisch ein (in der unteren Nullstellung) und aus (beim Heben aus der Nullstellung)

Arrêt des bras à insertion automatique et désinsertion automatique à terre

Parada de brazos de activación automática y desenganche automático de tierra

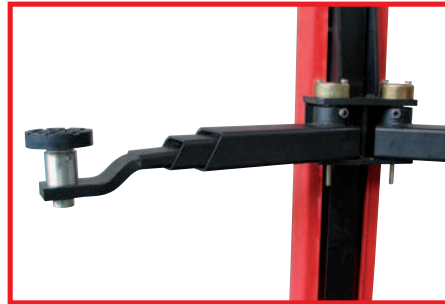

Comando a uomo presente, 24V

**Dead man controls, 24V**

24V - Totman-Schaltung

Commande "homme mort", 24V

Mandos de hombre presente, 24V

Bracci predisposti per l'alloggiamento rapido di prolunghe

**Arms suitable for quick drop-in extensions**

Aufnahmen mit Schnellstecksystem erleichtern den Einsatz von Verlängerungen.

Bras prévus pour le montage rapide de rallonges

Brazos predisuestos para el alojamiento rápido de suplementos.

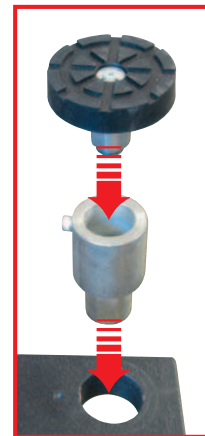

**Opzioni**



**Optionals**



**Sonderzubehör**



**Options**



**Opcionales**



Kit energy: supporto attrezzi e prese aria e corrente

**Kit energy: tool support, air connection and electric power plug**

Kit Energy: Werkzeughalter, Luftanschluss und Steckdose

Kit énergie: support outils, prises d'air et de courant

Kit energy: soporte herramientas y conexiones de aire y de corriente

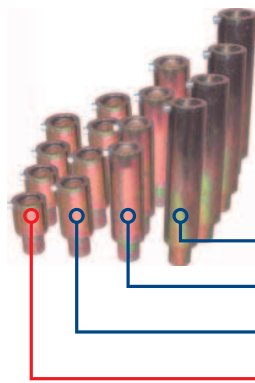

Estensioni per tamponi (kit 4 pz)

**Lifting pad extensions (4 pcs set)**

Hubspindelverlängerungen (Satz 4 Stk)

Rallonges pour tampons (jeu de 4 pcs)

Extensiones para tacos (kit 4 un.)

250 mm (L955)

170 mm (L954)

100 mm (L953)

60 mm (L956 standard included)

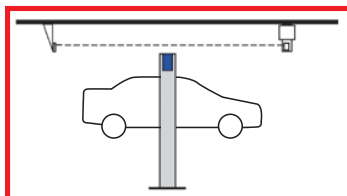

Kit fotocellula a soffitto

**Ceiling fitted cut-off sensor**

Hubenschalter zur Installation unter Decke



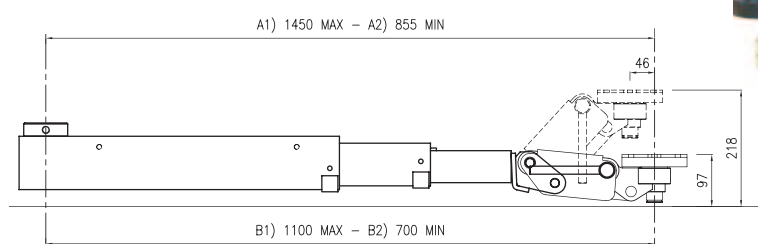
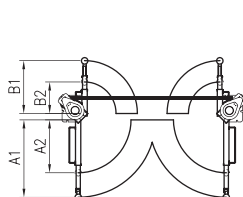

Capteur fin de course installé au plafond

Kit fotocélula instalada en el techo

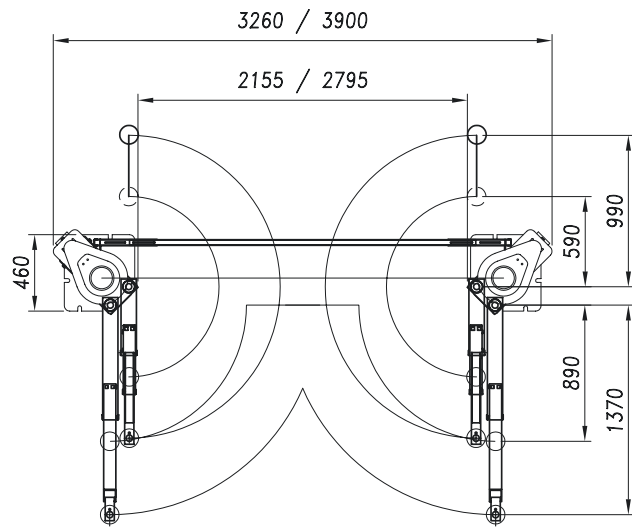
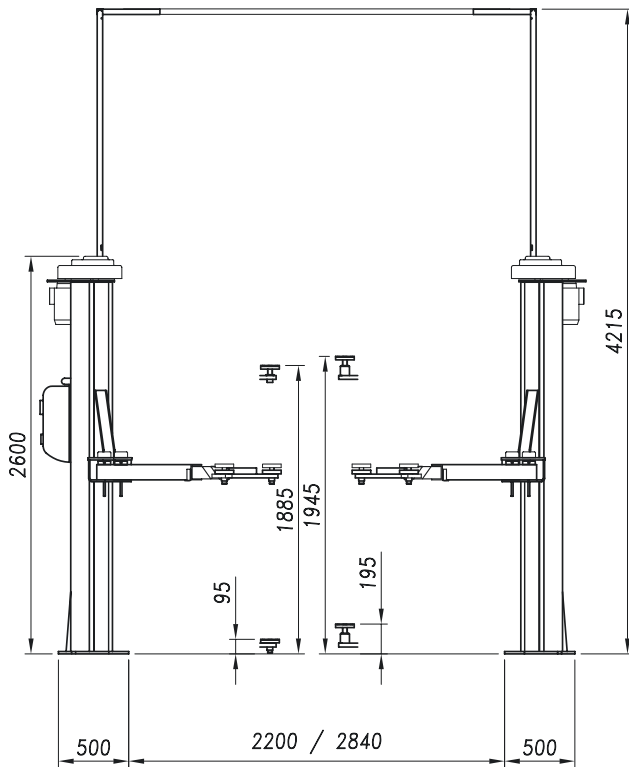
Tamponi click system • Click system pads • Tragteller mit Click System • Tampons de levage click system • Tacos click system





 <b>Dati tecnici</b>	 <b>Technical data</b>	 <b>Technische Eigenschaften</b>	 <b>Caractéristiques techniques</b>	 <b>Datos técnicos</b>	
Portata	<b>Capacity</b>	Tragfähigkeit	Capacité	Capacidad	<b>3.000 kg</b>
Peso	<b>Weight</b>	Gewicht	Poids	Peso	<b>600 kg</b>
Salita/Discesa	<b>Lifting/lowering</b>	Hub/Senkzeit	Levage/descente	Subida/Bajada	<b>65 s</b> <b>(52 s high speed optional)</b>
Altezza di sollevamento	<b>Lifting height</b>	Hubhöhe	Hauteur de levage	Altura de elevación	<b>1885 mm</b>
Motore	<b>Motor</b>	Motorleistung	Puissance moteur	Motor	<b>2 x 2,6 kW - 3 ph</b> <b>230-400V/50 Hz</b>

The company reserves the right to introduce improvements in design or specification without prior notice